

WARNING

Reduce Risk of Strangulation to Infants and Toddlers.
Position Safety Cord-Stops before using Blinds.

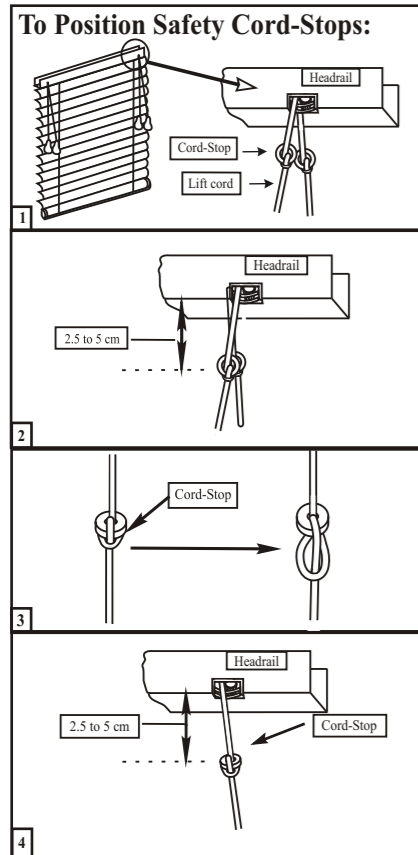

- 1 Install blind as directed by manufacturer, making sure headrail is securely fastened. Lower blind to maximum desired length and lock into place.
- 2 Measure the distance from headrail to cord-stops. If cord-stops are 2.5 to 5 cm below the headrail, no further adjustment is needed. Your blind is ready to be used.
- 3 If cord-stops ARE NOT 2.5 to 5 cm below headrail, loosen (but do not untie) the knot surrounding the cord-stop.
- 4 Push both the cord-stop and the loosened knot toward the headrail until the cord-stop is 2.5 to 5 cm below the headrail. Hold cord-stop in place and pull firmly on lift cord to re-tighten knot. Repeat steps 2, 3 & 4 for each cord-stop.

NOTE : Use of Hold Down Brackets is recommended to fully utilize the safety feature of the cord-stops.

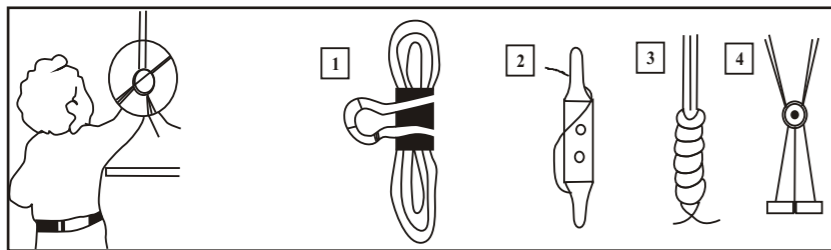

WARNING! Children can be strangled in blind or drapery cords. To keep cords out of reach of children, use these methods:

1. Clamp or clothes pin
2. Cleat
3. Tie the cord to itself
4. Tie-down device

SUNWOOD 50MM BASSWOOD SOLID TIMBER VENETIAN BLINDS Installation Instructions

Mounting Hardware:

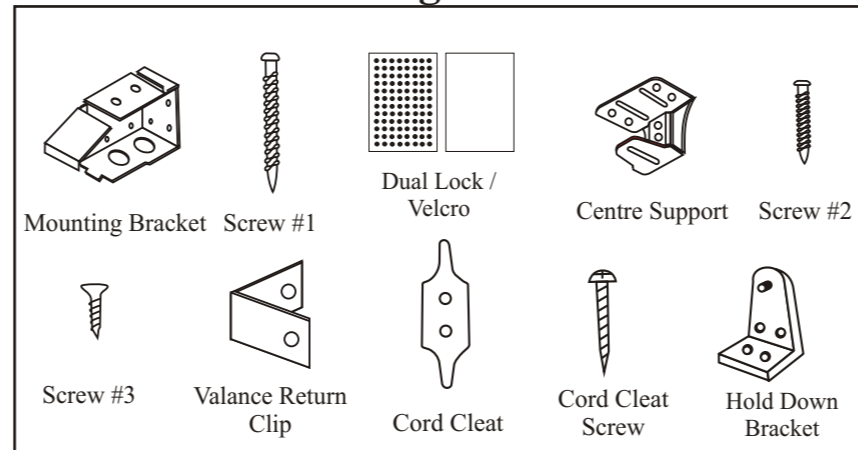

(Note : Centre support supplied for blind width 100 cm or over)

Tools Recommended for Installation:

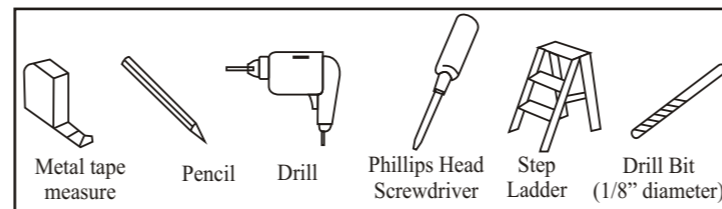

RECOMMENDED CARE FOR WOODEN BLINDS

1. When opening or closing blind, only raise or lower the blind when the slats are in the horizontal (open position). Larger blinds must be raised or lowered in stages. Raising or lowering in one singular motion places excessive stress on the mechanism, strings and brackets. Do not force the cord when tilting the blinds, this may cause The mechanism to break.
2. It is not recommended that wooden blinds be fitted in damp or wet environments as warpage may occur.
3. Dust blinds regularly.
4. If the blind becomes damp or wet, wipe down immediately. The slats should be horizontal (open) and the blind released and lowered completely. Allow to dry by removing the blinds from the brackets and lay down on a hard surface. Do not place in direct sunlight as excessive heat may cause the slats to warp. If the blinds are excessively wet, do not place the blinds on to a surface that may absorb any stain.
5. This wooden blind does not require any oiling.

If you have any doubts about the care or maintenance of your wooden blind, do not hesitate to contact your nearest supplier for advice.

MOUNTING INSTRUCTIONS

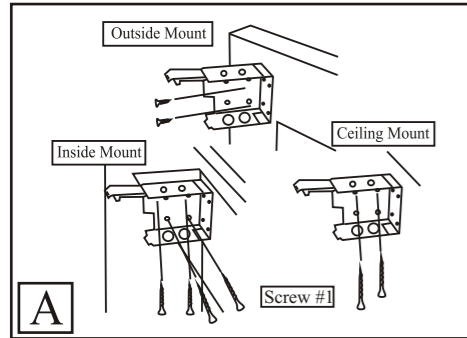

Brackets should be placed at the width of blind's head rail 6mm past each end. The bracket doesn't necessarily need to touch the inside face of the window frame.

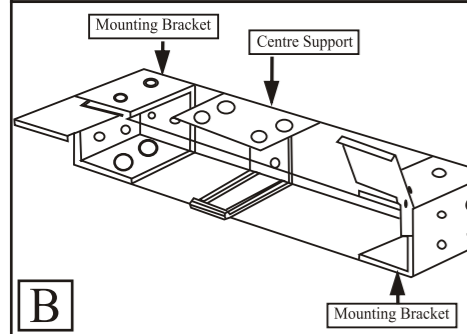

Align the top of the centre support bracket with the top of the mounting bracket before installation. Install with the bigger flap of the centre support bracket on the top side and clear of the slat ladder positions.

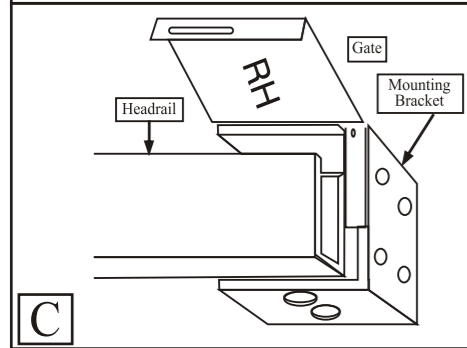

Push rail into brackets. Then press gate to close brackets.

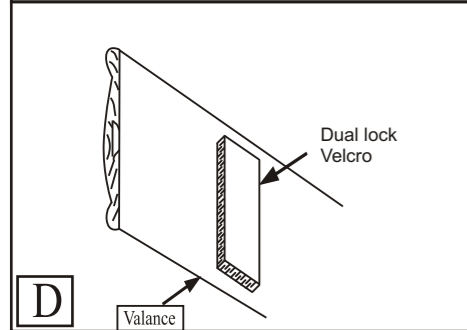

Stick the dual lock / velcro onto the valance.

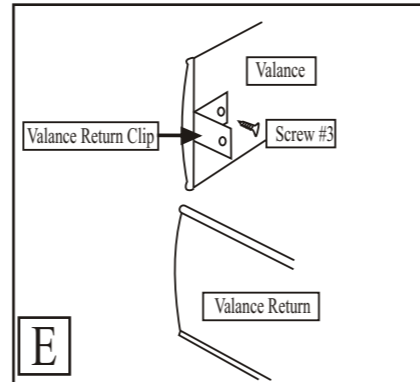

For Outside Mount: Screw one end of the valance return clip onto the valance using Screw #3. Align the edge of the valance return with the valance. Screw the other end of the valance return clip onto the valance return.

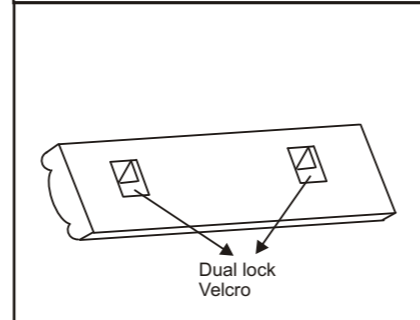

** Remove covering tape from velcro fastenings.
** Position valance to head rail and stick securely
** Valance can now be removed by pulling Velcro and refit accordingly.

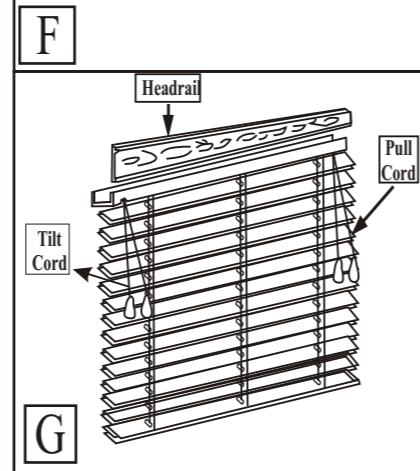

Always tilt blind horizontally before raising/lowering to extend the life of the blind. **To Lower Blind:** Move cord to left, pulling down gently until cord lock releases. **To Raise Blind:** Pull cord downward until blind reaches desired height. **To Lock cords:** pull cord right and release. Cord will lock automatically.

Installing Hold Down Brackets (optional):

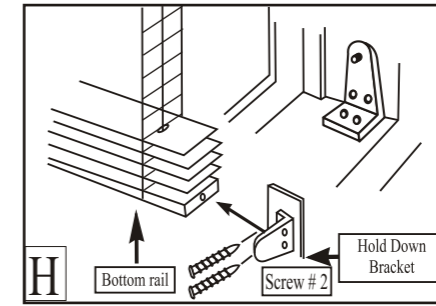

Hold down brackets: Using two small screws, screw hold down bracket to window facing or wall. Snap bracket pin ends into the hole at bottom rail end.